

रोल नं.

Roll No.

परीक्षार्थी कोड को उत्तर-पुस्तिका के मुख-पृष्ठ पर अवश्य लिखें ।

Candidates must write the Code on the title page of the answer-book.

- कृपया जाँच कर लें कि इस प्रश्न-पत्र में मुद्रित पृष्ठ 16 हैं ।
- प्रश्न-पत्र में दाहिने हाथ की ओर दिए गए कोड नम्बर को छात्र उत्तर-पुस्तिका के मुख-पृष्ठ पर लिखें ।
- कृपया जाँच कर लें कि इस प्रश्न-पत्र में 26 प्रश्न हैं ।
- कृपया प्रश्न का उत्तर लिखना शुरू करने से पहले, प्रश्न का क्रमांक अवश्य लिखें ।
- इस प्रश्न-पत्र को पढ़ने के लिए 15 मिनट का समय दिया गया है । प्रश्न-पत्र का वितरण पूर्वाह्न में 10.15 बजे किया जायेगा । 10.15 बजे से 10.30 बजे तक छात्र केवल प्रश्न-पत्र को पढ़ेंगे और इस अवधि के दौरान वे उत्तर-पुस्तिका पर कोई उत्तर नहीं लिखेंगे ।
- Please check that this question paper contains 16 printed pages.
- Code number given on the right hand side of the question paper should be written on the title page of the answer-book by the candidate.
- Please check that this question paper contains 26 questions.
- Please write down the Serial Number of the question before attempting it.
- 15 minute time has been allotted to read this question paper. The question paper will be distributed at 10.15 a.m. From 10.15 a.m. to 10.30 a.m., the students will read the question paper only and will not write any answer on the answer-book during this period.

## भौतिक विज्ञान (सैद्धान्तिक)

### PHYSICS (Theory)

निर्धारित समय : 3 घंटे

अधिकतम अंक : 70

Time allowed : 3 hours

Maximum Marks : 70

सामान्य निर्देश :

- सभी प्रश्न अनिवार्य हैं । इस प्रश्न-पत्र में कुल 26 प्रश्न हैं ।
- इस प्रश्न-पत्र के 5 भाग हैं : खण्ड-अ, खण्ड-ब, खण्ड-स, खण्ड-द और खण्ड-य ।
- खण्ड-अ में 5 प्रश्न हैं, प्रत्येक का 1 अंक है । खण्ड-ब में 5 प्रश्न हैं, प्रत्येक के 2 अंक हैं । खण्ड स में 12 प्रश्न हैं, प्रत्येक के 3 अंक हैं । खण्ड द में 4 अंक का एक मूल्याधारित प्रश्न है और खण्ड य में 3 प्रश्न हैं, प्रत्येक के 5 अंक हैं ।
- प्रश्न-पत्र में समग्र पर कोई विकल्प नहीं है । तथापि, दो अंकों वाले एक प्रश्न में, तीन अंकों वाले एक प्रश्न में और पाँच अंकों वाले तीनों प्रश्नों में आन्तरिक चयन प्रदान किया गया है । ऐसे प्रश्नों में आपको दिए गए चयन में से केवल एक प्रश्न ही करना है ।



(v) जहाँ आवश्यक हो, आप निम्नलिखित भौतिक नियतांकों के मानों का उपयोग कर सकते हैं :

$$c = 3 \times 10^8 \text{ m/s}$$

$$h = 6.63 \times 10^{-34} \text{ Js}$$

$$e = 1.6 \times 10^{-19} \text{ C}$$

$$\mu_0 = 4\pi \times 10^{-7} \text{ T m A}^{-1}$$

$$\epsilon_0 = 8.854 \times 10^{-12} \text{ C}^2 \text{ N}^{-1} \text{ m}^{-2}$$

$$\frac{1}{4\pi\epsilon_0} = 9 \times 10^9 \text{ N m}^2 \text{ C}^{-2}$$

$$\text{इलेक्ट्रॉन का द्रव्यमान} = 9.1 \times 10^{-31} \text{ kg}$$

$$\text{न्यूट्रॉन का द्रव्यमान} = 1.675 \times 10^{-27} \text{ kg}$$

$$\text{प्रोटॉन का द्रव्यमान} = 1.673 \times 10^{-27} \text{ kg}$$

$$\text{आवोगाद्रो संख्या} = 6.023 \times 10^{23} \text{ प्रति ग्राम मोल}$$

$$\text{बॉल्ट्ज़मान नियतांक} = 1.38 \times 10^{-23} \text{ JK}^{-1}$$

### General Instructions :

(i) All questions are compulsory. There are 26 questions in all.

(ii) This question paper has five sections : Section A, Section B, Section C, Section D and Section E.

(iii) Section A contains five questions of one mark each, Section B contains five questions of two marks each, Section C contains twelve questions of three marks each, Section D contains one value based question of four marks and Section E contains three questions of five marks each.

$\leq -L \frac{dI}{dt}$  (iv)

There is no overall choice. However, an internal choice has been provided in one question of two marks, one question of three marks and all the three questions of five marks weightage. You have to attempt only one of the choices in such questions.

(v) You may use the following values of physical constants wherever necessary :

$$c = 3 \times 10^8 \text{ m/s}$$

$$h = 6.63 \times 10^{-34} \text{ Js}$$

$$e = 1.6 \times 10^{-19} \text{ C}$$

$$\mu_0 = 4\pi \times 10^{-7} \text{ T m A}^{-1}$$

$$\epsilon_0 = 8.854 \times 10^{-12} \text{ C}^2 \text{ N}^{-1} \text{ m}^{-2}$$

$$\frac{1}{4\pi\epsilon_0} = 9 \times 10^9 \text{ N m}^2 \text{ C}^{-2}$$

$$\text{Mass of electron} = 9.1 \times 10^{-31} \text{ kg}$$

$$\text{Mass of neutron} = 1.675 \times 10^{-27} \text{ kg}$$

$$\text{Mass of proton} = 1.673 \times 10^{-27} \text{ kg}$$

$$\text{Avogadro's number} = 6.023 \times 10^{23} \text{ per gram mole}$$

$$\text{Boltzmann constant} = 1.38 \times 10^{-23} \text{ JK}^{-1}$$



खण्ड - अ  
SECTION - A

Q-90

1. कोई लम्बा सीधा धारावाही तार किसी वृत्ताकार पाश के केन्द्र से अभिलम्बवत गुजरता है। यदि इस तार से प्रवाहित धारा में वृद्धि होती है, तो क्या पाश में कोई emf प्रेरित होगी। अपने उत्तर की पुष्टि कीजिए। 1

A long straight current carrying wire passes normally through the centre of circular loop. If the current through the wire increases, will there be an induced emf in the loop? Justify.

2. विद्युत और चुम्बकीय क्षेत्रों द्वारा निर्वात में विद्युत चुम्बकीय तरंगों की चाल किस प्रकार निर्धारित की जाती है? 1

How is the speed of em-waves in vacuum determined by the electric and magnetic fields?

3. उस संधि डायोड का नाम लिखिए जिसका I-V अभिलाक्षणिक नीचे दिए अनुसार खींचा गया है : 1

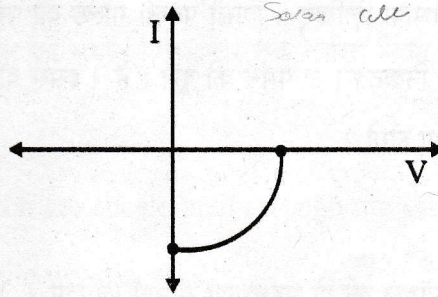

Name the junction diode whose I-V characteristics are drawn below :

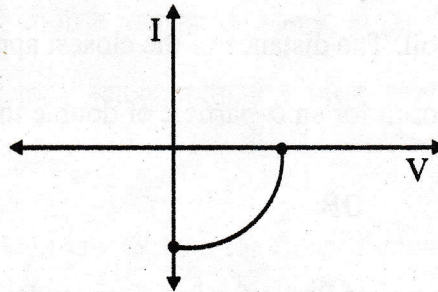



4. किसी स्थान पर पृथ्वी के चुम्बकीय क्षेत्र का क्षैतिज घटक B तथा नमन कोण  $60^\circ$  है। विषुवद्-वृत्त पर पृथ्वी के चुम्बकीय क्षेत्र का क्षैतिज घटक क्या है ?

1

At a place, the horizontal component of earth's magnetic field is B and angle of dip is  $60^\circ$ . What is the value of horizontal component of the earth's magnetic field at equator ?

5. किसी धातु के गोले को दिया गया आवेश क्या इस पर निर्भर करता है कि गोला ठोस है अथवा खोखला ? अपने उत्तर के लिए कारण दीजिए।

1

Does the charge given to a metallic sphere depend on whether it is hollow or solid ? Give reason for your answer.

### खण्ड - ब

### SECTION - B

6. निकटतम उपगमन की दूरी की परिभाषा लिखिए। किसी पतली गोल्ड की पन्नी पर गतिज ऊर्जा K के किसी  $\alpha$ -कण द्वारा बमबारी की गयी है। निकटतम उपगमन की दूरी r है। इससे दो गुनी गतिज ऊर्जा के  $\alpha$ -कण के लिए निकटतम उपगमन की दूरी क्या होगी ?

2

अथवा

रदरफोर्ड के परमाणु के नाभिकीय मॉडल की दो महत्वपूर्ण सीमाएँ लिखिए।

Define the distance of closest approach. An  $\alpha$ -particle of kinetic energy 'K' is bombarded on a thin gold foil. The distance of the closest approach is 'r'. What will be the distance of closest approach for an  $\alpha$ -particle of double the kinetic energy ?

OR

Write two important limitations of Rutherford nuclear model of the atom.

55/1/3

4



7. दो पिण्ड कब ठीक-ठीक विभेदित होते हैं ? व्याख्या कीजिए । किसी संयुक्त सूक्ष्मदर्शी की विभेदन क्षमता में किस प्रकार वृद्धि की जा सकती है । अपने उत्तर की पुष्टि के लिए प्रासंगिक सूत्र लिखिए । 2

When are two objects just resolved ? Explain. How can the resolving power of a compound microscope be increased ? Use relevant formula to support your answer.

8. (i) दृष्टि रेखा संचार क्या है ? 2

(ii) TV सिगनलों के प्रेषण के लिए व्योम तरंगों का उपयोग क्यों संभव नहीं है ? ऊँचाई 'h' के एन्टेना द्वारा कितनी दूरी तक किसी सिगनल का प्रेषण किया जा सकता है ?

(i) What is the line of sight communication ?

(ii) Why is it not possible to use sky waves for transmission of TV signals ? Upto what distance can a signal be transmitted using an antenna of height 'h' ?

9. किसी  $\alpha$ -कण और किसी प्रोटॉन को समान विभवान्तर तक त्वरित किया गया है । इनकी दे-ब्राग्ली तरंगदैर्घ्यों का अनुपात ज्ञात कीजिए । 2

An  $\alpha$ -particle and a proton are accelerated through the same potential difference. Find the ratio of their de Broglie wavelengths.

$$\lambda_p = 2\lambda \quad \lambda_m = 2\lambda$$

10. जब किसी संधारित्र को बैटरी से आवेशित किया जा रहा होता है, तो इस संधारित्र से प्रवाहित धारा के विषय में ऐम्पियर-मैक्सवेल नियम किस प्रकार व्याख्या करता है ? विद्युत फ्लक्स की दर के परिवर्तन के पदों में विस्थापन धारा के लिए व्यंजक लिखिए । 2

How does Ampere-Maxwell law explain the flow of current through a capacitor when it is being charged by a battery ? Write the expression for the displacement current in terms of the rate of change of electric flux.



11. किसी चल कुण्डली गैल्वेनोमीटर के कार्यकारी सिद्धान्त का वर्णन कीजिए । किसी गैल्वेनोमीटर में (i) अरीय चुम्बकीय क्षेत्र और (ii) बेलनाकार नरम लौह क्रोड का उपयोग करना आवश्यक क्यों है ? इस गैल्वेनोमीटर की धारा सुग्राह्यता के लिए व्यंजक लिखिए ।

3

क्या किसी गैल्वेनोमीटर को इसी रूप में धारा की माप करने में उपयोग किया जा सकता है ? व्याख्या कीजिए ।

अथवा

- (a) स्वप्रेरकत्व की परिभाषा और इसका S.I. मात्रक लिखिए ।
- (b) दो परिनलिकाओं  $S_1$  और  $S_2$  के अन्योन्य प्रेरकत्व के लिए व्यंजक प्राप्त कीजिए । जबकि ये परिनलिकाएँ लम्बी एवं समाक्ष हैं, समान लम्बाई  $L$  की हैं, एक-दूसरे पर लिपटी हैं, त्रिज्याएँ  $r_1$  और  $r_2$  तथा प्रति एकांक लम्बाई फेरों की संख्या  $n_1$  और  $n_2$  हैं और बाहरी परिनलिका  $S_2$  से धारा  $I$  प्रवाहित होती है ।

Describe the working principle of a moving coil galvanometer. Why is it necessary to use (i) a radial magnetic field and (ii) a cylindrical soft iron core in a galvanometer ?

Write the expression for current sensitivity of the galvanometer.

Can a galvanometer as such be used for measuring the current ? Explain.

OR

- (a) Define the term 'self-inductance' and write its S.I. unit.



- (b) Obtain the expression for the mutual inductance of two long co-axial solenoids  $S_1$  and  $S_2$  wound one over the other, each of length  $L$  and radii  $r_1$  and  $r_2$  and  $n_1$  and  $n_2$  number of turns per unit length, when a current  $I$  is set up in the outer solenoid  $S_2$ .

12. (i) किसी रेडियोएक्टिव नाभिक 'A' का नीचे दिए अनुसार श्रेणी में क्षय होता है : 3

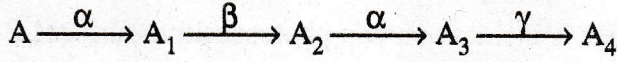

$A_2$  की द्रव्यमान संख्या और परमाणु संख्या क्रमशः 176 और 71 हैं।  $A_4$  और A की द्रव्यमान और परमाणु संख्या निर्धारित कीजिए।

- (ii)  $\beta^+$  और  $\beta^-$  क्षयों में होने वाली मूल नाभिकीय प्रक्रियाएँ लिखिए।

- (i) A radioactive nucleus 'A' undergoes a series of decays as given below :

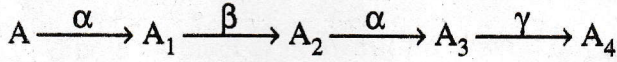

The mass number and atomic number of  $A_2$  are 176 and 71 respectively.

Determine the mass and atomic numbers of  $A_4$  and A.

- (ii) Write the basic nuclear processes underlying  $\beta^+$  and  $\beta^-$  decays.

13. किसी CE ट्रांजिस्टर प्रवर्धक में  $2 \text{ k}\Omega$  के संग्राहक प्रतिरोध के सिरों पर श्रव्य सिगनल वोल्टता  $2\text{V}$  है। दिया गया है कि इस ट्रांजिस्टर का धारा प्रवर्धन गुणांक 100 है। यदि आधार प्रतिरोध का मान  $1 \text{ k}\Omega$  है तो निवेशी सिगनल वोल्टता और आधार धारा ज्ञात कीजिए। 3

For a CE-transistor amplifier, the audio signal voltage across the collector resistance of  $2 \text{ k}\Omega$  is  $2\text{V}$ . Given the current amplification factor of the transistor is 100, find the input signal voltage and base current, if the base resistance is  $1 \text{ k}\Omega$ .



14. (i) आइंस्टीन के प्रकाश-विद्युत समीकरण के दो महत्वपूर्ण लक्षणों का उल्लेख कीजिए । 3

(ii) दो प्रकाश-सुग्राही पृष्ठों P और Q पर  $10^{15}$  Hz आवृत्ति का विकिरण आपतन करता है । पृष्ठ P से कोई प्रकाश इलेक्ट्रॉन उत्सर्जन नहीं होता । पृष्ठ Q से प्रकाश इलेक्ट्रॉन उत्सर्जन तो होता है परन्तु प्रकाश इलेक्ट्रॉनों की गतिज ऊर्जा शून्य है । इन प्रेक्षणों की व्याख्या कीजिए तथा पृष्ठ Q के लिए कार्य फलन का मान ज्ञात कीजिए ।

(i) State two important features of Einstein's photoelectric equation.

(ii) Radiation of frequency  $10^{15}$  Hz is incident on two photosensitive surfaces P and Q. There is no photoemission from surface P. Photoemission occurs from surface Q but photoelectrons have zero kinetic energy. Explain these observations and find the value of work function for surface Q.

15. (i) नीचे दर्शाए गए श्रेणी LCR परिपथ में धारा और वोल्टता के बीच कलान्तर का मान ज्ञात कीजिए । धारा अथवा वोल्टता में कौन अग्रगामी है ? 3

(ii) अन्य कोई परिवर्तन किए बिना, संधारित्र C से पार्श्व में संयोजित किए जाने वाले उस अतिरिक्त संधारित्र  $C_1$  का मान ज्ञात कीजिए । जिससे कि परिपथ का शक्ति गुणांक एकांक हो जाए ।

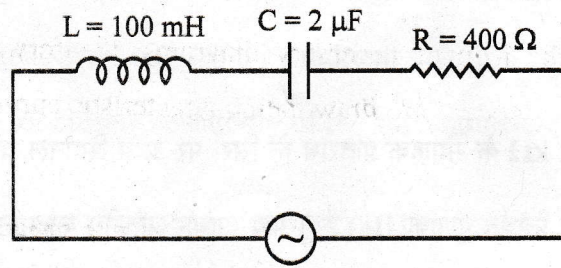

$$V = V_0 \sin(1000t + \phi)$$

$\omega = 1000$   
 $\omega RC = 1000$

(i) Find the value of the phase difference between the current and the voltage in the series LCR circuit shown below. Which one leads in phase : current or voltage ?



- (ii) Without making any other change, find the value of the additional capacitor  $C_1$ , to be connected in parallel with the capacitor  $C$ , in order to make the power factor of the circuit unity.

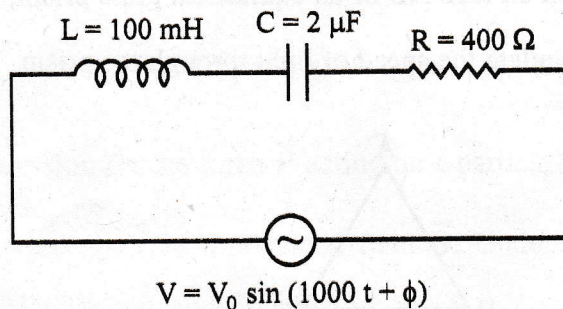

16. (i) किसी एकसमान विद्युत क्षेत्र  $\vec{E}$  में स्थित द्विध्रुव आघूर्ण  $\vec{p}$  के किसी विद्युत द्विध्रुव द्वारा अनुभव किए जाने वाले बल-आघूर्ण  $\vec{\tau}$  के लिए व्यंजक प्राप्त कीजिए । 3
- (ii) यदि क्षेत्र एकसमान नहीं है, तो क्या होगा ?
- (i) Obtain the expression for the torque  $\vec{\tau}$  experienced by an electric dipole of dipole moment  $\vec{p}$  in a uniform electric field,  $\vec{E}$ .
- (ii) What will happen if the field were not uniform ?

17. आवश्यक आरेखों की सहायता से किसी p-n संधि डायोड के अग्रदिशिक और पश्चदिशिक बायसन की संक्षेप में व्याख्या कीजिए । दोनों प्रकरणों में इनके अभिलाक्षणिक वक्र भी खींचिए । 3

Explain briefly with the help of necessary diagrams, the forward and the reverse biasing of a p-n junction diode. Also draw their characteristic curves in the two cases.

18. (i) किसी समबाहु काँच के प्रिज्म के फलक AB पर आपतित कोई प्रकाश किरण  $30^\circ$  का न्यूनतम विचलन दर्शाती है । प्रिज्म में प्रकाश की चाल परिकलित कीजिए । 3

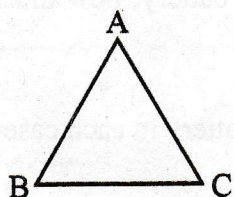



- (ii) फलक AB पर वह आपतन कोण ज्ञात कीजिए जिसके लिए निर्गत किरण फलक AC के अनुदिश संस्पर्श करती है ।
- (i) A ray of light incident on face AB of an equilateral glass prism, shows minimum deviation of  $30^\circ$ . Calculate the speed of light through the prism.

45°

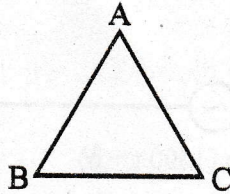

- (ii) Find the angle of incidence at face AB so that the emergent ray grazes along the face AC.

19. आयाम मॉड्यूलन की परिभाषा लिखिए । उन किन्हीं दो कारकों की व्याख्या कीजिए, जो किसी निम्न आवृत्ति आधार बैंड सिगनल के मॉड्यूलन की आवश्यकता की पुष्टि करते हैं ।

3

Define the term 'amplitude modulation'. Explain any two factors which justify the need for modulating a low frequency base-band signal.

20. 12 pF के दो सर्वसम संधारित्र श्रेणी क्रम में संयोजित हैं और इस संयोजन के सिरों से 50 V की बैटरी संयोजित है । इस संयोजन में संचित कुल ऊर्जा कितनी है ? यदि इन दोनों संधारित्रों को पार्श्व में संयोजित करके इसी बैटरी से संयोजित किया जाए, तो अब इस संयोजन में कितनी ऊर्जा संचित होगी ?

3

प्रत्येक प्रकरण में बैटरी से ली गयी धारा भी ज्ञात कीजिए ।

Two identical capacitors of 12 pF each are connected in series across a battery of 50 V. How much electrostatic energy is stored in the combination ? If these were connected in parallel across the same battery, how much energy will be stored in the combination now ?

Also find the charge drawn from the battery in each case.

55/1/3

10



21. (a) किसी चुम्बकीय क्षेत्र  $\vec{B}$  में वेग  $\vec{V}$  से गतिमान द्रव्यमान  $m$  और आवेश  $q$  के किसी कण पर लगने वाले बल  $\vec{F}$  के लिए व्यंजक लिखिए । किन स्थितियों में यह कण (i) वृत्तीय पथ और (ii) कुंडलिनी पथ पर गति करेगा ? 3

(b) यह दर्शाइए कि चुम्बकीय क्षेत्र में गतिमान कण की गतिज ऊर्जा नियत रहती है ।

(a) Write the expression for the force  $\vec{F}$  acting on a particle of mass  $m$  and charge  $q$  moving with velocity  $\vec{V}$  in a magnetic field  $\vec{B}$ . Under what conditions will it move in (i) a circular path and (ii) a helical path ?

(b) Show that the kinetic energy of the particle moving in magnetic field remains constant.

22. किसी प्रतिरोध  $R$  को पोटेंशियोमीटर से धारा प्राप्त हो रही है । पोटेंशियोमीटर के तार  $AB$  का कुल प्रतिरोध  $R_0$  है । इस पोटेंशियोमीटर को वोल्टता  $V$  की आपूर्ति की गयी है ।  $R$  के सिरो पर वोल्टता के लिए व्यंजक व्युत्पन्न कीजिए जबकि सर्पी सम्पर्क पोटेंशियोमीटर तार के मध्य में हैं । 3

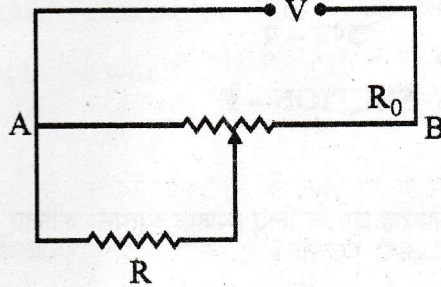

A resistance of  $R$  draws current from a potentiometer. The potentiometer wire,  $AB$ , has a total resistance of  $R_0$ . A voltage  $V$  is supplied to the potentiometer. Derive an expression for the voltage across  $R$  when the sliding contact is in the middle of potentiometer wire.

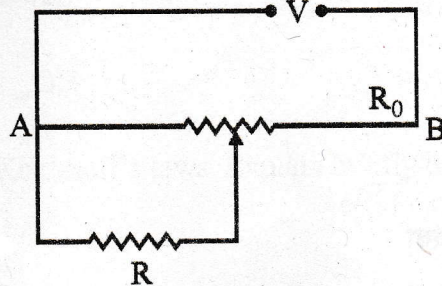

$$V_0 = 2V$$



खण्ड - द

SECTION - D

23. श्रीमती रश्मि सिंह के चश्मे के लेंस टूट गए। जब वह दुकानदार के पास गयीं तो दुकानदार ने उन्हें काँच के लेंसों के स्थान पर प्लास्टिक के लेंसों का चश्मा बनवाने का सुझाव दिया। नया चश्मा प्राप्त करने पर उन्होंने यह पाया कि नये चश्मे के लेंस पहले वाले चश्मे की तुलना में मोटे हैं। उन्होंने इसके बारे में दुकानदार से प्रश्न किया परन्तु वह संतोषजनक उत्तर नहीं दे पाया। घर पहुँचने पर उन्होंने यही प्रश्न अपनी बेटी अनुजा से पूछा और उसने प्लास्टिक के लेंसों के मोटे होने की व्याख्या की।

(a) अनुजा और उसकी माताजी प्रत्येक के द्वारा दर्शाए गए दो गुणों को लिखिए।

(b) लेंस मेकर सूत्र द्वारा आप इस तथ्य की व्याख्या किस प्रकार करेंगे ?

4

Mrs. Rashmi Singh broke her reading glasses. When she went to the shopkeeper to order new specs, he suggested that she should get spectacles with plastic lenses instead of glass lenses. On getting the new spectacles, she found that the new ones were thicker than the earlier ones. She asked this question to the shopkeeper but he could not offer satisfactory explanation for this. At home, Mrs. Singh raised the same question to her daughter Anuja who explained why plastic lenses were thicker.

(a) Write two qualities displayed each by Anuja and her mother.

(b) How do you explain this fact using lens maker's formula ?

खण्ड - ए

SECTION - E

24. (i) किसी चालक में इलेक्ट्रॉनों के अपवाह वेग के लिए व्यंजक व्युत्पन्न कीजिए। इस प्रकार ओम के नियम की उत्पत्ति कीजिए।

5

(ii) कोई तार जिसकी अनुप्रस्थ-काट में एक सिरे से दूसरे सिरे तक रेखिकतः वृद्धि हो रही है किसी V वोल्ट की बैटरी से संयोजित है। तार में निम्नलिखित में से कौन सी राशियाँ नियत रहती है ?

(a) अपवाह वेग

(b) धारा घनत्व

(c) विद्युत धारा

(d) विद्युत क्षेत्र

अपने उत्तरों की पुष्टि कीजिए।

अथवा

55/1/3

12



- (a) किरखोफ के दो नियम लिखिए । संक्षेप में व्याख्या कीजिए कि ये नियम किस प्रकार न्यायसंगत हैं ।
- (b) चित्र में दर्शाए गए प्रतिरोधकों के नेटवर्क, जिसमें प्रत्येक प्रतिरोधक का प्रतिरोध  $r$  है, को उससे संयोजित आंतरिक प्रतिरोध  $r$  और emf  $E$  के किसी सेल द्वारा धारा प्रदान की गयी है । (i) सेल से ली गयी धारा और (ii) नेटवर्क में उपभुक्त शक्ति के लिए व्यंजक प्राप्त कीजिए ।

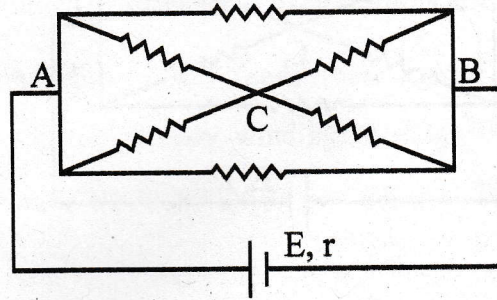

- (i) Derive an expression for drift velocity of electrons in a conductor. Hence deduce Ohm's law.
- (ii) A wire whose cross-sectional area is increasing linearly from its one end to the other, is connected across a battery of  $V$  volts. Which of the following quantities remain constant in the wire ?
- (a) drift speed
- (b) current density
- (c) electric current
- (d) electric field *(ans)*

Justify your answer.

OR

- (i) State the two Kirchhoff's laws. Explain briefly how these rules are justified.





- (ii) The current is drawn from a cell of emf  $E$  and internal resistance  $r$  connected to the network of resistors each of resistance  $r$  as shown in the figure. Obtain the expression for (i) the current drawn from the cell and (ii) the power consumed in the network.

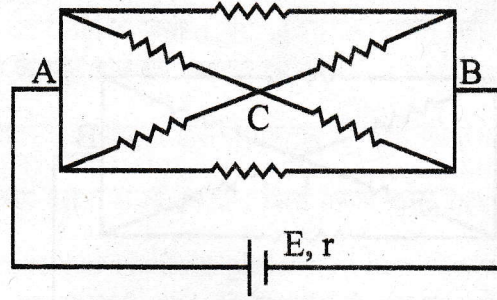

25. (a) किसी AC जनित्र का नामांकित आरेख खींचिए । कुण्डली में प्रेरित emf के तात्क्षणिक मान के लिए व्यंजक व्युत्पन्न कीजिए ।
- (b)  $3.0 \times 10^{-2} T$  परिमाण के किसी एकसमान चुम्बकीय क्षेत्र में 20 फेरों और  $200 \text{ cm}^2$  अनुप्रस्थ-काट की किसी वृत्ताकार कुण्डली को इसके ऊर्ध्वाधर व्यास के परितः  $50 \text{ rad s}^{-1}$  की कोणीय चाल से घूर्णित किया गया है । इस कुण्डली में अधिकतम धारा का मान परिकलित कीजिए ।

5

अथवा

- (a) किसी उपचायी ट्रांसफॉर्मर का नामांकित आरेख खींचिए । दो कुण्डलियों में फेरों की संख्या और धाराओं के पदों में द्वितीयक और प्राथमिक वोल्टताओं का अनुपात प्राप्त कीजिए ।
- (b) कोई शक्ति संचरण लाइन किसी अपचायी ट्रांसफॉर्मर को 2200 V पर निवेश शक्ति का भरण करती है । इस ट्रांसफॉर्मर की प्राथमिक कुण्डली में 3000 फेरे हैं । 220 V पर निर्गत शक्ति प्राप्त करने के लिए द्वितीयक कुण्डली में फेरों की संख्या ज्ञात कीजिए ।
- (a) Draw a labelled diagram of AC generator. Derive the expression for the instantaneous value of the emf induced in the coil.

55/1/3

14



- (b) A circular coil of cross-sectional area  $200 \text{ cm}^2$  and 20 turns is rotated about the vertical diameter with angular speed of  $50 \text{ rad s}^{-1}$  in a uniform magnetic field of magnitude  $3.0 \times 10^{-2} \text{ T}$ . Calculate the maximum value of the current in the coil.

OR

- (a) Draw a labelled diagram of a step-up transformer. Obtain the ratio of secondary to primary voltage in terms of number of turns and currents in the two coils.
- (b) A power transmission line feeds input power at 2200 V to a step-down transformer with its primary windings having 3000 turns. Find the number of turns in the secondary to get the power output at 220 V.

26. (a) अधुवित प्रकाश और रैखिकतः ध्रुवित प्रकाश के बीच विभेदन कीजिए । किसी पोलैरॉयड की सहायता से रैखिकतः ध्रुवित प्रकाश किस प्रकार प्राप्त किया जाता है ।
- (b) किसी पोलैरॉयड  $P_1$  पर, तीव्रता  $I_0$  का अधुवित प्रकाश का कोई पतला पुन्ज आपतन करता है । इस पोलैरॉयड द्वारा पारगमित प्रकाश फिर दूसरे पोलैरॉयड  $P_2$  पर, जिसका पास-अक्ष  $P_1$  के पास-अक्ष के सापेक्ष  $60^\circ$  का कोण बनाता है, आपतन करता है ।  $P_2$  से पारगमित प्रकाश की तीव्रता ज्ञात कीजिए ।

5

अथवा

- (a) यंग के द्विझिरी प्रयोग के व्यतिकरण पैटर्न और एकल झिरी के कारण प्राप्त विवर्तन पैटर्न के बीच विभेदनकारी दो लक्षणों की व्याख्या कीजिए ।
- (b)  $500 \text{ nm}$  तरंगदैर्घ्य का एकवर्णी प्रकाश  $0.2 \text{ mm}$  चौड़ाई की किसी एकल झिरी पर अभिलम्बवत् आपतन करके विवर्तन पैटर्न उत्पन्न करता है । पर्दे पर प्राप्त केन्द्रीय उच्चिष्ठ की कोणीय चौड़ाई ज्ञात कीजिए ।

एकल झिरी के कारण केन्द्रीय उच्चिष्ठ के कुल कोणीय प्रसार के क्षेत्र में समायोजित किए जा सकने वाले  $05 \text{ mm}$  चौड़ाई वाले फ्रिन्ज के यंग के द्विझिरी प्रयोग में प्राप्त फ्रिन्जों की संख्या का आकलन कीजिए ।



- (a) Distinguish between unpolarized light and linearly polarized light. How does one get linearly polarised light with the help of a polaroid ?
- (b) A narrow beam of unpolarised light of intensity  $I_0$  is incident on a polaroid  $P_1$ . The light transmitted by it is then incident on a second polaroid  $P_2$  with its pass axis making angle of  $60^\circ$  relative to the pass axis of  $P_1$ . Find the intensity of the light transmitted by  $P_2$ .

OR

- (a) Explain two features to distinguish between the interference pattern in Young's double slit experiment with the diffraction pattern obtained due to a single slit.
- (b) A monochromatic light of wavelength 500 nm is incident normally on a single slit of width 0.2 mm to produce a diffraction pattern. Find the angular width of the central maximum obtained on the screen.

Estimate the number of fringes obtained in Young's double slit experiment with fringe width 0.5 mm, which can be accommodated within the region of total angular spread of the central maximum due to single slit.



## MARKING SCHEME

Q. No.	Expected Answer/ Value Points	Marks	Total Marks						
<b>SECTION B</b>									
Q1	No, As the magnetic field due to current carrying wire will be in the plane of the circular loop, so magnetic flux will remain zero. Alternatively [Magnetic flux does not change with the change of current.]	½ ½	1						
Q2	Speed of em waves is determined by the ratio of the peak values of electric and magnetic field vectors. [Alternatively, Give full credit, if student writes directly $C = \frac{E_0}{B_0}$ ]	1	1						
Q3	Solar cell	1	1						
Q4	$B_H = B_E \cos \delta$ $B = B_E \cos 60^\circ \Rightarrow B_E = 2B$ At equator $\delta = 0^\circ$ $\therefore B_H = 2B \cos 0 = 2B$ [Alternatively, Award full one mark, if student doesn't take the value (=2B) of $B_E$ , while finding the value of horizontal component at equator, and just writes the formula only.]	½ ½	1						
Q5	No, Because the charge resides only on the surface of the conductor.	½ ½	1						
Q6	<table border="1" style="width: 100%; border-collapse: collapse;"> <tr> <td style="padding: 2px;">Definition of distance of closest approach</td> <td style="text-align: right; padding: 2px;">1</td> </tr> <tr> <td style="padding: 2px;">Finding of distance of closest approach when Kinetic energy is doubled</td> <td style="text-align: right; padding: 2px;">1</td> </tr> </table> <p>It is the distance of charged particle from the centre of the nucleus, at which the whole of the initial kinetic energy of the (far off) charged particle gets converted into the electric potential energy of the system. Distance of closest approach (<math>r_c</math>) is given by</p> $r_c = \frac{1}{4\pi\epsilon_0} \cdot \frac{2Ze^2}{K}$ <p>'K' is doubled, <math>\therefore r_c</math> becomes <math>\frac{r}{2}</math></p> <p>[Alternatively: If a candidate writes directly <math>\frac{r}{2}</math> without mentioning formula, award the 1 mark for this part.]</p> <p style="text-align: center;"><b>OR</b></p> <table border="1" style="width: 100%; border-collapse: collapse;"> <tr> <td style="padding: 2px;">Two important limitations of Rutherford nuclear model</td> <td style="text-align: right; padding: 2px;">1+1</td> </tr> </table> <p>1. According to Rutherford model, electron orbiting around the nucleus, continuously radiates energy due to the acceleration; hence the atom will not remain stable.</p>	Definition of distance of closest approach	1	Finding of distance of closest approach when Kinetic energy is doubled	1	Two important limitations of Rutherford nuclear model	1+1	1 ½ ½ 1	2
Definition of distance of closest approach	1								
Finding of distance of closest approach when Kinetic energy is doubled	1								
Two important limitations of Rutherford nuclear model	1+1								





	2. As electron spirals inwards; its angular velocity and frequency change continuously; therefore it will emit a continuous spectrum.	1	2
Q7	<div style="border: 1px solid black; padding: 5px;">           Condition, when two objects are just resolved <math>\frac{1}{2}</math>            For increasing the resolving power of a compound microscope <math>1 \frac{1}{2}</math> </div> <p>Two objects are said to be just resolved when, in their diffraction patterns, central maxima of one object coincides with the first minima, of the diffraction pattern of the second object.</p> <p>Limit of resolution of compound microscope</p> $d_{min} = \frac{1.22\lambda}{2 n \sin \beta}$ <p>Resolving power is the reciprocal of limit of resolution (<math>d_{min}</math>)</p> <p>Therefore, to increase resolving power <math>\lambda</math> can be reduced and refractive index of the medium can be increased.</p>	$\frac{1}{2}$	$\frac{1}{2}$
Q8	<div style="border: 1px solid black; padding: 5px;">           (i) Definition of line of sight communication 1            (ii) Reason why it is not possible to use sky waves for transmission of T.V. signals <math>\frac{1}{2}</math>            Range of an antenna <math>\frac{1}{2}</math> </div> <p>(i) Communication, using waves which travel in straight line from transmitting antenna to receiving antenna.</p> <p>(ii) Because T.V. signal waves are not reflected back by the ionosphere.</p> $d = \sqrt{2hR}$	1	$\frac{1}{2}$
Q9	<div style="border: 1px solid black; padding: 5px;">           Finding the ratio of de Broglie wavelength <math>\left(\frac{\lambda_\alpha}{\lambda_p}\right)</math> </div> $\lambda = \frac{h}{p} = \frac{h}{\sqrt{2mK}} = \frac{h}{\sqrt{2mqV}}$ $\therefore \frac{\lambda_\alpha}{\lambda_p} = \frac{h}{\sqrt{2m_\alpha q_\alpha V}} \times \frac{\sqrt{2m_p q_p V}}{h}$ $\frac{\lambda_\alpha}{\lambda_p} = \frac{\sqrt{m_p q_p}}{\sqrt{m_\alpha q_\alpha}}$ $= \frac{\sqrt{m_p q_p}}{\sqrt{4m_p 2q_p}}$ $= \frac{1}{2\sqrt{2}}$ $\lambda_\alpha : \lambda_p = 1 : 2\sqrt{2}$	$\frac{1}{2}$	$\frac{1}{2}$





Q10	<table border="1" style="width: 100%;"> <tbody> <tr> <td>Explanation of flow of current through capacitor</td> <td style="text-align: right;">1</td> </tr> <tr> <td>Expression for displacement current</td> <td style="text-align: right;">1</td> </tr> </tbody> </table> <p>During charging, electric flux between the plates of capacitor keeps on changing; this results in the production of a displacement current between the plates.</p> $I_d = \epsilon_0 \frac{d\phi_E}{dt} \left( / I_d = \epsilon_0 A \frac{dE}{dt} \right)$	Explanation of flow of current through capacitor	1	Expression for displacement current	1	1	2										
Explanation of flow of current through capacitor	1																
Expression for displacement current	1																
Q11	<table border="1" style="width: 100%;"> <tbody> <tr> <td>Working Principle of moving coil galvanometer</td> <td style="text-align: right;">1</td> </tr> <tr> <td>Necessity of (i) radial magnetic field</td> <td style="text-align: right;">½</td> </tr> <tr> <td>(ii) cylindrical soft iron core</td> <td style="text-align: right;">½</td> </tr> <tr> <td>Expression for current sensitivity</td> <td style="text-align: right;">½</td> </tr> <tr> <td>Explanation of use of Galvanometer to measure current</td> <td style="text-align: right;">½</td> </tr> </tbody> </table> <p>When a coil, carrying current, and free to rotate about a fixed axis, is placed in a uniform magnetic field, it experiences a torque (which is balanced by a restoring torque of suspension).</p> <p>(i) To have deflection proportional to current / to maximize the deflecting torque acting on the current carrying coil.</p> <p>(ii) To make magnetic field radial / to increase the strength of magnetic field.</p> <p>Expression for current sensitivity</p> $I_s = \frac{\theta}{I} \text{ or } \frac{NAB}{K}$ <p>where <math>\theta</math> is the deflection of the coil</p> <p>No</p> <p>The galvanometer, can only detect currents but cannot measure them as it is not calibrated. The galvanometer coil is likely to be damaged by currents in the (mA/A) range]</p> <p style="text-align: center;"><b>OR</b></p> <table border="1" style="width: 100%;"> <tbody> <tr> <td>a) Definition of self inductance and its SI unit</td> <td style="text-align: right;">1 + ½</td> </tr> <tr> <td>b) Derivation of expression for mutual inductance</td> <td style="text-align: right;">1 ½</td> </tr> </tbody> </table> <p>Self inductance of a coil equals, the magnitude of the magnetic flux, linked with it, when a unit current flows through it.</p> <p>Alternatively</p> <p>Self inductance, of a coil, equals the magnitude of the emf induced in it, when the current in the coil, is changing at a unit rate.</p> <p>SI unit : henry / (weber/ampere) / (ohm second.)</p>	Working Principle of moving coil galvanometer	1	Necessity of (i) radial magnetic field	½	(ii) cylindrical soft iron core	½	Expression for current sensitivity	½	Explanation of use of Galvanometer to measure current	½	a) Definition of self inductance and its SI unit	1 + ½	b) Derivation of expression for mutual inductance	1 ½	1 ½ ½ ½ ½ ½	3
Working Principle of moving coil galvanometer	1																
Necessity of (i) radial magnetic field	½																
(ii) cylindrical soft iron core	½																
Expression for current sensitivity	½																
Explanation of use of Galvanometer to measure current	½																
a) Definition of self inductance and its SI unit	1 + ½																
b) Derivation of expression for mutual inductance	1 ½																



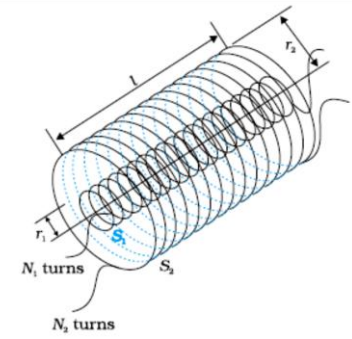

	 <p>When current <math>I_2</math> is passed through coil <math>S_2</math>, it in turn sets up a magnetic flux through <math>S_1</math>: <math>\Phi_1 = (n_1 \ell)(\pi r_1^2)(B_2)</math></p> <p><math>\Phi_1 = (n_1 \ell)(\pi r_1^2)(\mu_0 n_2 I_2)</math>  <math>\Phi_1 = \mu_0 n_1 n_2 I_2 \pi r_1^2 \ell</math>          But <math>\Phi_1 = M_{12} I_2</math>  <math>\Rightarrow M_{12} = \mu_0 n_1 n_2 \pi r_1^2 \ell</math></p> <p>[Note : If the student derives the correct expression, without giving the diagram of two coaxial coils, full credit can be given]</p>	<p><math>\frac{1}{2}</math></p> <p><math>\frac{1}{2}</math></p> <p><math>\frac{1}{2}</math></p>	<p>3</p>				
<p>Q12</p>	<table border="1" data-bbox="267 861 1177 976"> <tr> <td>(i) Determining the mass and atomic number of <math>A_4</math> and A</td> <td><math>\frac{1}{2} \times 4</math></td> </tr> <tr> <td>(ii) Basic nuclear processes of <math>\beta^+</math> and <math>\beta^-</math> decays</td> <td><math>\frac{1}{2} + \frac{1}{2}</math></td> </tr> </table> <p>(i) <math>A_4</math> : Mass Number : 172                    i. Atomic Number : 69</p> <p>(ii) A : Mass Number : 180                 i. Atomic Number : 72</p> <p>[Alternatively : Give full credit if student considers <math>\beta^+</math> decay and find atomic and mass numbers accordingly</p> <p><math>{}_{72}^{180}A \xrightarrow{\alpha} {}_{70}^{176}A_1 \xrightarrow{\beta^-} {}_{71}^{176}A_2 \xrightarrow{\alpha} {}_{69}^{172}A_3 \xrightarrow{r} {}_{69}^{172}A_4</math></p> <p>Gives the values quoted above.</p> <p>If the student takes <math>\beta^+</math> decay</p> <p><math>{}_{74}^{180}A \xrightarrow{\alpha} {}_{72}^{176}A_1 \xrightarrow{\beta^+} {}_{71}^{176}A_2 \xrightarrow{\alpha} {}_{69}^{172}A_3 \xrightarrow{r} {}_{69}^{172}A_4</math></p> <p>This would give the answers: (<math>A_4</math>:172,69);(A:180,74)]</p> <p>Basic nuclear process for <math>\beta^+</math> decay <math>p \rightarrow n + {}_1^0e + \nu</math></p> <p>For <math>\beta^-</math> decay <math>n \rightarrow p + {}_{-1}^0e + \bar{\nu}</math></p> <p>[Note: Give full credit of this part, if student writes the processes as conversion of proton into neutron for <math>\beta^+</math> decay and neutron into proton for <math>\beta^-</math> decay.]</p>	(i) Determining the mass and atomic number of $A_4$ and A	$\frac{1}{2} \times 4$	(ii) Basic nuclear processes of $\beta^+$ and $\beta^-$ decays	$\frac{1}{2} + \frac{1}{2}$	<p><math>\frac{1}{2}</math></p> <p><math>\frac{1}{2}</math></p> <p><math>\frac{1}{2}</math></p> <p><math>\frac{1}{2}</math></p> <p><math>\frac{1}{2}</math></p> <p><math>\frac{1}{2}</math></p>	<p>3</p>
(i) Determining the mass and atomic number of $A_4$ and A	$\frac{1}{2} \times 4$						
(ii) Basic nuclear processes of $\beta^+$ and $\beta^-$ decays	$\frac{1}{2} + \frac{1}{2}$						
<p>Q13</p>	<table border="1" data-bbox="267 1701 1177 1816"> <tr> <td>Calculation of collector current <math>I_C</math>, base current <math>I_B</math> and input signal voltage <math>V_i</math></td> <td>1+1+1</td> </tr> </table> <p>Given <math>R_C = 2\text{k}\Omega</math>  <math>= 2 \times 10^3 \Omega</math></p>	Calculation of collector current $I_C$ , base current $I_B$ and input signal voltage $V_i$	1+1+1	<p><math>\frac{1}{2}</math></p>			
Calculation of collector current $I_C$ , base current $I_B$ and input signal voltage $V_i$	1+1+1						



	$V_{CE} = I_c R_c$ $I_c = \frac{V_{CE}}{R_c} = \frac{2}{2 \times 10^3} A$ $= 10^{-3} A$ $= 1 mA$ <p>current gain</p> $\beta = \frac{I_c}{I_B}$ $\therefore 100 = \frac{10^{-3}}{I_B}$ $\therefore I_B = 10^{-5} A$ <p>Input signal voltage</p> $V_i = I_B R_B$ $= 1 \times 10^{-5} \times 10^3 \Omega$ $= 10^{-2} V$ <p>[Note : Give full credit if student calculates the required quantities by any other alternative method ]</p>	<p>1/2</p> <p>1/2</p> <p>1/2</p> <p>1/2</p> <p>1/2</p>	3						
Q14	<table border="1" data-bbox="272 779 1175 911"> <tbody> <tr> <td>(i) Two important features of Einstein's photo electric equation</td> <td>1/2 + 1/2</td> </tr> <tr> <td>(ii) Explanation of observations and finding value of work function of Surface Q</td> <td>1+1</td> </tr> </tbody> </table> <p>(i) Maximum kinetic energy (<math>K_{max}</math>), of emitted electrons, depends linearly on frequency of incident radiations</p> $(KE)_{max} = h\nu - h\nu_0$ <p>Existence of threshold frequency for the metal surface <math>\phi_0 = h\nu_0</math></p> <p>(Any other relevant feature)</p> <p>(ii) Since no photoelectric emission takes place from P it means frequency of incident radiation (<math>10^{15} \text{ Hz}</math>) is less than its threshold frequency (<math>\nu_0</math>)<sub>P</sub>. Photo emission takes place from Q but kinetic energy of photoelectrons is zero. This implies that frequency of incident radiation is just equal to the threshold frequency of Q.</p> <p>For Q, work function <math>\phi_0 = h\nu_0</math></p> $= \frac{6.6 \times 10^{-34} \times 10^{15}}{1.6 \times 10^{-19}} eV$ $= 4.125 eV$	(i) Two important features of Einstein's photo electric equation	1/2 + 1/2	(ii) Explanation of observations and finding value of work function of Surface Q	1+1	<p>1/2 + 1/2</p> <p>1/2</p> <p>1/2</p> <p>1/2</p> <p>1/2</p>	3		
(i) Two important features of Einstein's photo electric equation	1/2 + 1/2								
(ii) Explanation of observations and finding value of work function of Surface Q	1+1								
Q15	<table border="1" data-bbox="289 1507 1175 1640"> <tbody> <tr> <td>(i) Calculation of phase difference between current and voltage</td> <td>1</td> </tr> <tr> <td>Name of quantity which leads</td> <td>1/2</td> </tr> <tr> <td>(ii) Calculation of value of 'C', is to be connected in parallel</td> <td>1 1/2</td> </tr> </tbody> </table> <p>(i) <math>X_L = \omega L = (1000 \times 100 \times 10^{-3}) \Omega = 100 \Omega</math></p> $X_C = \frac{1}{\omega C} = \left( \frac{1}{1000 \times 2 \times 10^{-6}} \right) \Omega = 500 \Omega$ <p>Phase angle</p>	(i) Calculation of phase difference between current and voltage	1	Name of quantity which leads	1/2	(ii) Calculation of value of 'C', is to be connected in parallel	1 1/2	1/2	
(i) Calculation of phase difference between current and voltage	1								
Name of quantity which leads	1/2								
(ii) Calculation of value of 'C', is to be connected in parallel	1 1/2								



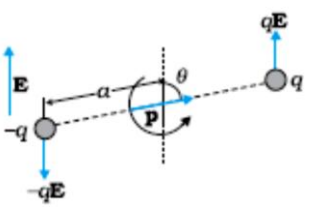

	$\tan \Phi = \frac{X_L - X_C}{R}$ $\tan \Phi = \frac{100-500}{400} = -1$ $\Phi = -\frac{\pi}{4}$ <p>As <math>X_C &gt; X_L</math>, ( /phase angle is negative), hence current leads voltage</p> <p>(ii) To make power factor unity</p> $X_{C'} = X_L$ $\frac{1}{\omega C'} = 100$ $C' = 10\mu F$ $C' = C + C_1$ $10 = 2 + C_1$ $C_1 = 8\mu F$	<p>1/2</p> <p>1/2</p> <p>1/2</p> <p>1/2</p>	<p>3</p>						
<p>Q16</p>	<table border="1" style="width: 100%; border-collapse: collapse;"> <tr> <td style="padding: 5px;">(i) Obtaining of the expression for torque experienced by an electric dipole</td> <td style="text-align: right; padding: 5px;">2</td> </tr> <tr> <td style="padding: 5px;">(ii) Effect of non uniform electric field</td> <td style="text-align: right; padding: 5px;">1</td> </tr> </table> <p>(i)</p>  <p>Force on + q, <math>\vec{F} = q\vec{E}</math></p> <p>Force on - q, <math>\vec{F} = -q\vec{E}</math></p> <p>Magnitude of torque</p> $\tau = qE \times 2a \sin \theta$ $= 2qa E \sin \theta$ $\vec{\tau} = \vec{p} \times \vec{E}$ <p>(ii) If the electric field is non uniform, the dipole experiences a translatory force as well as a torque.</p>	(i) Obtaining of the expression for torque experienced by an electric dipole	2	(ii) Effect of non uniform electric field	1	<p>1/2</p> <p>1/2</p> <p>1/2</p> <p>1/2</p> <p>1</p>	<p>3</p>		
(i) Obtaining of the expression for torque experienced by an electric dipole	2								
(ii) Effect of non uniform electric field	1								
<p>Q17</p>	<table border="1" style="width: 100%; border-collapse: collapse;"> <tr> <td style="padding: 5px;">Circuit diagrams of p n junction under forward bias and reverse bias</td> <td style="text-align: right; padding: 5px;">1/2 + 1/2</td> </tr> <tr> <td style="padding: 5px;">Explanation of p n junction working for forward and reverse bias</td> <td style="text-align: right; padding: 5px;">1/2 + 1/2</td> </tr> <tr> <td style="padding: 5px;">Characteristic curves for the two cases</td> <td style="text-align: right; padding: 5px;">1/2 + 1/2</td> </tr> </table>	Circuit diagrams of p n junction under forward bias and reverse bias	1/2 + 1/2	Explanation of p n junction working for forward and reverse bias	1/2 + 1/2	Characteristic curves for the two cases	1/2 + 1/2		
Circuit diagrams of p n junction under forward bias and reverse bias	1/2 + 1/2								
Explanation of p n junction working for forward and reverse bias	1/2 + 1/2								
Characteristic curves for the two cases	1/2 + 1/2								

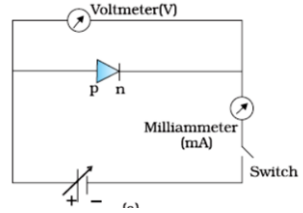
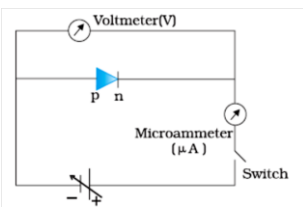
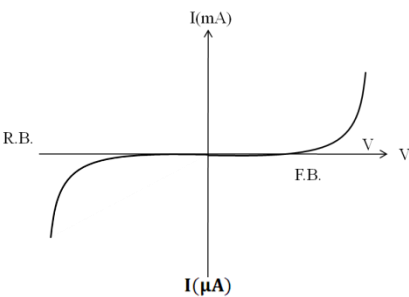

	<div style="display: flex; justify-content: space-around;">   </div> <p>In forward bias, applied voltage does not support potential barrier. As a result, the depletion layer width decreases and barrier height is reduced. Due to the applied voltage, electrons from n side cross the depletion region and reach p side. Similarly holes from p side cross the junction and reach the n side. The motion of charged carriers, on either side, give rise to current.</p> <p>In reverse bias, applied voltage support potential barrier. As a result, barrier height is increased, depletion layer widens. This suppresses the flow of electrons from n → p and holes from p → n. Diffusion current decreases. The electric field direction of the junction is such that if electrons on p side or holes on n side in their random motion comes close to the junction, they will be swept to its majority zone. This drift of carriers give rise to the current called reverse current.</p> 	<p><math>\frac{1}{2} + \frac{1}{2}</math></p> <p><math>\frac{1}{2}</math></p> <p><math>\frac{1}{2}</math></p> <p><math>\frac{1}{2} + \frac{1}{2}</math></p>	<p>3</p>				
<p>Q18</p>	<table border="1" style="width: 100%;"> <tr> <td>(i) Calculation of speed of light</td> <td style="text-align: right;">1 ½</td> </tr> <tr> <td>(ii) Calculation of angle of incidence at face AB</td> <td style="text-align: right;">1 ½</td> </tr> </table> <p>(i)</p> $\mu = \frac{\sin\left(\frac{A + \delta m}{2}\right)}{\sin\left(\frac{A}{2}\right)}$ $= \frac{\sin\left(\frac{60 + 30}{2}\right)}{\sin\left(\frac{60^\circ}{2}\right)} = \sqrt{2}$ <p>Also <math>\mu = \frac{c}{v} \Rightarrow v = \frac{3 \times 10^8}{\sqrt{2}} \text{ m/s}</math></p> $= 2.122 \times 10^8 \text{ m/s}$	(i) Calculation of speed of light	1 ½	(ii) Calculation of angle of incidence at face AB	1 ½	<p><math>\frac{1}{2}</math></p> <p><math>\frac{1}{2}</math></p> <p><math>\frac{1}{2}</math></p>	
(i) Calculation of speed of light	1 ½						
(ii) Calculation of angle of incidence at face AB	1 ½						



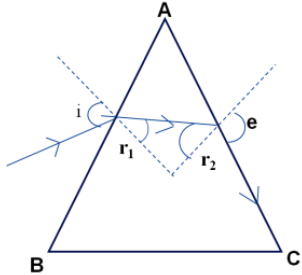

	<p>(ii)</p>  <p>At face AC, let the angle of incidence be <math>r_2</math>. For grazing ray, <math>e = 90^\circ</math>  <math>\Rightarrow \mu = \frac{1}{\sin r_2} \Rightarrow r_2 = \sin^{-1}\left(\frac{1}{\sqrt{2}}\right) = 45^\circ</math>          Let angle of refraction at face AB be <math>r_1</math>. Now <math>r_1 + r_2 = A</math>  <math>\therefore r_1 = A - r_2 = 60^\circ - 45^\circ = 15^\circ</math>          Let angle of incidence at this face be <math>i</math>  <math>\mu = \frac{\sin i}{\sin r_1}</math>  <math>\Rightarrow \sqrt{2} = \frac{\sin i}{\sin 15^\circ}</math>  <math>\therefore i = \sin^{-1}(\sqrt{2} \cdot \sin 15^\circ)</math></p>	<p><math>\frac{1}{2}</math></p> <p><math>\frac{1}{2}</math></p> <p><math>\frac{1}{2}</math></p>	<p>3</p>												
<p>Q19</p>	<table border="1" data-bbox="276 934 1144 1029"> <tr> <td>Definition of amplitude modulation</td> <td>1</td> </tr> <tr> <td>Explanation of two factors justifying the need of modulation</td> <td>2</td> </tr> </table> <p>It is the process of superposition of information/message signal over a carrier wave in such a way that the amplitude of carrier wave is varied according to the information signal/message signal.          Direct transmission, of the low frequency base band information signal, is not possible due to the following reasons;</p> <p>(i) Size of Antenna: For transmitting a signal, minimum height of antenna should be <math>\frac{\lambda}{4}</math>; with the help of modulation wavelength of signal decreases, hence height of antenna becomes manageable.</p> <p>(ii) Effective power radiated by an antenna:          Effective power radiated by an antenna varies inversely as <math>\lambda^2</math>, hence effective power radiated into the space, by the antenna, increases.</p> <p>(iii) To avoid mixing up of signals from different transmitters.          (Any two)</p>	Definition of amplitude modulation	1	Explanation of two factors justifying the need of modulation	2	<p>1</p> <p>1</p> <p><math>\frac{1}{2} + \frac{1}{2}</math></p>	<p>3</p>								
Definition of amplitude modulation	1														
Explanation of two factors justifying the need of modulation	2														
<p>Q20</p>	<table border="1" data-bbox="284 1585 1169 1837"> <tr> <td>Equivalent capacitance in series</td> <td><math>\frac{1}{2}</math></td> </tr> <tr> <td>Energy in series combination</td> <td><math>\frac{1}{2}</math></td> </tr> <tr> <td>Charge in series combination</td> <td><math>\frac{1}{2}</math></td> </tr> <tr> <td>Equivalent capacitance in parallel combination</td> <td><math>\frac{1}{2}</math></td> </tr> <tr> <td>Energy in parallel combination</td> <td><math>\frac{1}{2}</math></td> </tr> <tr> <td>Charge in parallel combination</td> <td><math>\frac{1}{2}</math></td> </tr> </table>	Equivalent capacitance in series	$\frac{1}{2}$	Energy in series combination	$\frac{1}{2}$	Charge in series combination	$\frac{1}{2}$	Equivalent capacitance in parallel combination	$\frac{1}{2}$	Energy in parallel combination	$\frac{1}{2}$	Charge in parallel combination	$\frac{1}{2}$		
Equivalent capacitance in series	$\frac{1}{2}$														
Energy in series combination	$\frac{1}{2}$														
Charge in series combination	$\frac{1}{2}$														
Equivalent capacitance in parallel combination	$\frac{1}{2}$														
Energy in parallel combination	$\frac{1}{2}$														
Charge in parallel combination	$\frac{1}{2}$														

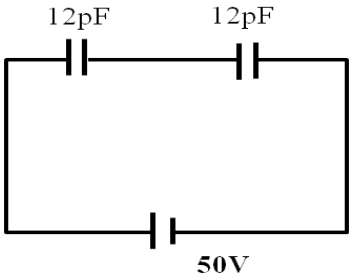
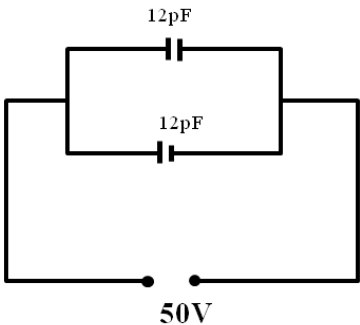
	 <p>In series combination: <math>\frac{1}{C_s} = \left(\frac{1}{12} + \frac{1}{12}\right) (pF)^{-1}</math>  <math>\therefore C_s = 6 \times 10^{-12} pF</math>  <math>U_s = \frac{1}{2} CV^2</math>  <math>U_s = \frac{1}{2} \times 6 \times 10^{-12} \times 50 \times 50 J</math>  <math>\therefore U_s = 75 \times 10^{-10} J</math>  <math>q_s = C_s V</math>  <math>= 6 \times 50</math>  <math>= 300 \times 10^{-12} C = 3 \times 10^{-10} C</math></p>  <p>In parallel combination: <math>C_p = (12 + 12) pF</math>  <math>\therefore C_p = 24 \times 10^{-12} F</math>  <math>U_s = \frac{1}{2} \times 24 \times 10^{-12} \times 2500 J</math>  <math>= 3 \times 10^{-8} J</math>  <math>q_p = C_p V</math>  <math>q_p = 24 \times 10^{-12} \times 50 C</math>  <math>q_p = 1.2 \times 10^{-9} C</math></p>	<p><math>\frac{1}{2}</math></p> <p><math>\frac{1}{2}</math></p> <p><math>\frac{1}{2}</math></p> <p><math>\frac{1}{2}</math></p> <p><math>\frac{1}{2}</math></p> <p><math>\frac{1}{2}</math></p> <p><math>\frac{1}{2}</math></p> <p><math>\frac{1}{2}</math></p>	<p>3</p>								
<p>Q21</p>	<table border="1" style="width: 100%;"> <tbody> <tr> <td>(a) Expression for force acting on charged particle</td> <td style="text-align: right;">1</td> </tr> <tr> <td>    (i) Condition for circular path</td> <td style="text-align: right;"><math>\frac{1}{2}</math></td> </tr> <tr> <td>    (ii) Condition for helical path</td> <td style="text-align: right;"><math>\frac{1}{2}</math></td> </tr> <tr> <td>(b) Showing Kinetic energy is constant</td> <td style="text-align: right;">1</td> </tr> </tbody> </table> <p>(a) <math>\vec{F} = q(\vec{v} \times \vec{B})</math>                  (i) When velocity of charged particle and magnetic field are perpendicular to each other.                  (ii) When velocity is neither parallel nor perpendicular to the</p>	(a) Expression for force acting on charged particle	1	(i) Condition for circular path	$\frac{1}{2}$	(ii) Condition for helical path	$\frac{1}{2}$	(b) Showing Kinetic energy is constant	1	<p>1</p> <p><math>\frac{1}{2}</math></p>	
(a) Expression for force acting on charged particle	1										
(i) Condition for circular path	$\frac{1}{2}$										
(ii) Condition for helical path	$\frac{1}{2}$										
(b) Showing Kinetic energy is constant	1										



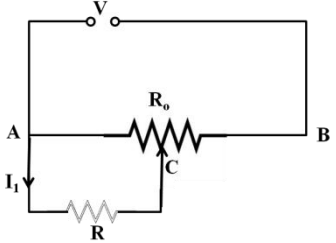

	<p>magnetic field.</p> <p>(b) The force, experienced by the charged particle, is perpendicular to the instantaneous velocity <math>\vec{v}</math>, at all instants. Hence the magnetic force cannot bring any change in the speed of the charged particle. Since speed remains constant, the kinetic energy also stays constant.</p>	1/2	
		1	3
Q22	<div style="border: 1px solid black; padding: 5px; margin-bottom: 10px;">                 Derivation of expression of voltage across resistance R <span style="float: right;">3</span> </div>  <p>Resistance between points A &amp; C</p> $\frac{1}{R_1} = \frac{1}{R} + \frac{1}{\left(\frac{R_o}{2}\right)}$ <p>Effective resistance between points A &amp; B</p> $R_2 = \left(\frac{R \frac{R_o}{2}}{R + \frac{R_o}{2}}\right) + \frac{R_o}{2}$ <p>Current drawn from the voltage source, <math>I = \frac{V}{R_2}</math></p> $I = \frac{V}{\left(\frac{R \frac{R_o}{2}}{R + \frac{R_o}{2}}\right) + \frac{R_o}{2}}$ <p>Let current through R be <math>I_1</math></p> $I_1 = \frac{I \left(\frac{R_o}{2}\right)}{R + \frac{R_o}{2}}$ <p>Voltage across R</p> $V_I = I_1 R$ $= \frac{I R_o}{2 \left(R + \frac{R_o}{2}\right)} \cdot R$ $= \frac{R R_o}{2 \left(R + \frac{R_o}{2}\right)} \cdot \frac{V}{\left(\frac{R R_o}{2R + R_o}\right) + \frac{R_o}{2}}$ $= \frac{2RV}{R_o + 4R}$	1/2	
		1/2	
		1/2	
		1/2	
		1/2	
		1/2	
		1/2	
		1/2	
Q23	<div style="border: 1px solid black; padding: 5px; margin-bottom: 10px;">                 a) Two qualities each of Anuja and her mother <span style="float: right;">1/2 x 4</span>                  b) Explanation, using lens maker's formula <span style="float: right;">2</span> </div> <p>a) Anuja : Scientific temperament, co-operative, knowledgeable (any</p>		
		1/2+ 1/2	

	<p>two)                  Mother : Inquisitive, scientific temper/keen to learn/has no airs(any two)(or any other two similar values)</p> <p>b) <math>\frac{1}{f} = \left(\frac{\mu_2}{\mu_1} - 1\right) \left(\frac{1}{R_1} - \frac{1}{R_2}\right)</math>                  As the refractive index of plastic material is less than that of glass material therefore, for the same power (<math>= 1/f</math>), the radius of curvature of plastic material is small.                  Therefore plastic lens is thicker.                  Alternatively, If student just writes that plastic has a different refractive index than glass, award one mark for this part.</p>	<p><math>\frac{1}{2} + \frac{1}{2}</math></p> <p><math>\frac{1}{2}</math></p> <p><math>\frac{1}{2}</math></p> <p><math>\frac{1}{2}</math></p> <p><math>\frac{1}{2}</math></p>	<p>4</p>						
<p>Q24</p>	<table border="1" data-bbox="272 577 1177 720"> <tr> <td>(i) Derivation of the expression for drift velocity</td> <td>2</td> </tr> <tr> <td>Deduction of Ohm's law</td> <td>2</td> </tr> <tr> <td>(ii) Name of quantity and justification</td> <td><math>\frac{1}{2} + \frac{1}{2}</math></td> </tr> </table> <p>Let an electric field E be applied the conductor. Acceleration of each electron is  <math>a = -\frac{eE}{m}</math>                  Velocity gained by the electron  <math>v = -\frac{eE}{m}t</math>                  Let the conductor contain n electrons per unit volume. The average value of time 't', between their successive collisions, is the relaxation time, 'τ'.                  Hence average drift velocity <math>v_d = \frac{-eE}{m} \tau</math>                  The amount of charge, crossing area A, in time Δt, is  <math>\equiv neAv_d\Delta t = I\Delta t</math>                  Substituting the value of <math>v_d</math>, we get  <math>I\Delta t = neA \left(\frac{eE\tau}{m}\right) \Delta t</math>  <math>\therefore I = \left(\frac{e^2 A\tau n}{m}\right) E = \sigma E, \left(\sigma = \frac{e^2\tau n}{m} \text{ is the conductivity}\right)</math>                  But <math>I = JA</math>, where J is the current density  <math>\Rightarrow J = \left(\frac{e^2\tau n}{m}\right) E</math>  <math>\Rightarrow J = \sigma E</math>                  This is Ohm's law                  [Note : Credit should be given if the student derives the alternative form of Ohm's law by substituting <math>E = \frac{V}{l}</math>]                  ii) Electric current will remain constant in the wire.                  All other quantities, depend on the cross sectional area of the wire.</p> <p style="text-align: center;"><b>OR</b></p>	(i) Derivation of the expression for drift velocity	2	Deduction of Ohm's law	2	(ii) Name of quantity and justification	$\frac{1}{2} + \frac{1}{2}$	<p><math>\frac{1}{2}</math></p> <p><math>\frac{1}{2}</math></p> <p><math>\frac{1}{2}</math></p> <p><math>\frac{1}{2}</math></p> <p><math>\frac{1}{2}</math></p> <p><math>\frac{1}{2}</math></p> <p><math>\frac{1}{2}</math></p> <p><math>\frac{1}{2}</math></p> <p><math>\frac{1}{2}</math></p>	<p>5</p>
(i) Derivation of the expression for drift velocity	2								
Deduction of Ohm's law	2								
(ii) Name of quantity and justification	$\frac{1}{2} + \frac{1}{2}$								

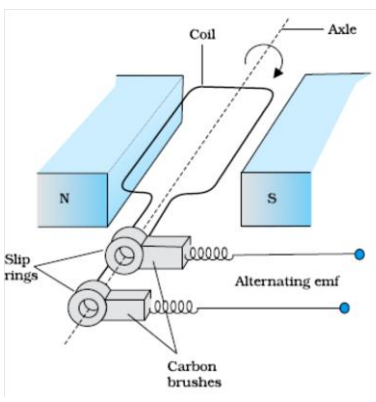

	<table border="1" style="width: 100%; border-collapse: collapse;"> <tr> <td style="padding: 5px;">(i) Statement of Kirchoff's laws</td> <td style="text-align: right; padding: 5px;">1+1</td> </tr> <tr> <td style="padding: 5px;">Justification</td> <td style="text-align: right; padding: 5px;"><math>\frac{1}{2} + \frac{1}{2}</math></td> </tr> <tr> <td style="padding: 5px;">(ii) Calculation of i) current drawn and</td> <td style="text-align: right; padding: 5px;">1</td> </tr> <tr> <td style="padding: 5px;">ii) Power consumed</td> <td style="text-align: right; padding: 5px;">1</td> </tr> </table> <p style="margin-top: 10px;">(i) Junction Rule: At any Junction, the sum of currents, entering the junction, is equal to the sum of currents leaving the junction.  Loop Rule: The Algebraic sum, of changes in potential, around any closed loop involving resistors and cells, in the loop is zero.  <math display="block">\sum(\Delta V) = 0</math> Justification: The first law is in accord with the law of conservation of charge.  The Second law is in accord with the law of conservation of energy.</p> <p>(ii) Equivalent resistance of the loop  <math display="block">R = \frac{r}{3}</math> Hence current drawn from the cell  <math display="block">I = \frac{E}{\frac{r}{3} + r} = \frac{3E}{4r}</math> Power consumed <math>P = I^2 (\frac{r}{3})</math>  <math display="block">= \frac{9E^2}{16r^2} \times \frac{4r}{3} = \frac{3E^2}{4r}</math>   [Note: Award the last 1 ½ marks for this part, if the calculations, for these parts, are done by using (any other) value of equivalent resistance obtained by the student.)</p>	(i) Statement of Kirchoff's laws	1+1	Justification	$\frac{1}{2} + \frac{1}{2}$	(ii) Calculation of i) current drawn and	1	ii) Power consumed	1	<p>1</p> <p>1</p> <p><math>\frac{1}{2}</math></p> <p><math>\frac{1}{2}</math></p> <p><math>\frac{1}{2}</math></p> <p><math>\frac{1}{2}</math></p> <p><math>\frac{1}{2}</math></p> <p><math>\frac{1}{2}</math></p>	<p>5</p>
(i) Statement of Kirchoff's laws	1+1										
Justification	$\frac{1}{2} + \frac{1}{2}$										
(ii) Calculation of i) current drawn and	1										
ii) Power consumed	1										
<p>Q25</p>	<table border="1" style="width: 100%; border-collapse: collapse;"> <tr> <td style="padding: 5px;">a) Labelled diagram of AC generator</td> <td style="text-align: right; padding: 5px;">1 ½</td> </tr> <tr> <td style="padding: 5px;">Expression for instantaneous value of induced emf.</td> <td style="text-align: right; padding: 5px;">1 ½</td> </tr> <tr> <td style="padding: 5px;">b) Calculation of maximum value of current</td> <td style="text-align: right; padding: 5px;">2</td> </tr> </table> <div style="text-align: center; margin-top: 20px;">  </div> <p style="margin-top: 10px;">[Deduct ½ mark, If diagram is not labeled]</p>	a) Labelled diagram of AC generator	1 ½	Expression for instantaneous value of induced emf.	1 ½	b) Calculation of maximum value of current	2	<p>1 ½</p>			
a) Labelled diagram of AC generator	1 ½										
Expression for instantaneous value of induced emf.	1 ½										
b) Calculation of maximum value of current	2										

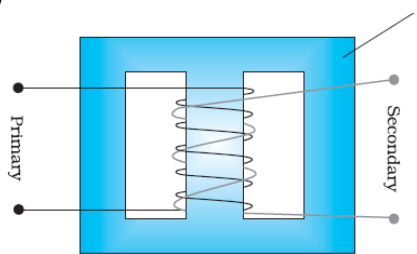
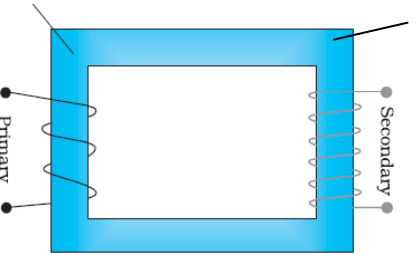
	<p>When the coil is rotated with constant angular speed <math>\omega</math>, the angle <math>\theta</math> between the magnetic field and area vector of the coil, at instant t, is given by <math>\theta = \omega t</math>,                  Therefore, magnetic flux, (<math>\phi_B</math>), at this instant, is  <math>\phi_B = BA \cos \omega t</math>  <math>\therefore</math> Induced emf <math>e = -N \frac{d\phi_B}{dt}</math>  <math>e = NBA \omega \sin \omega t</math>  <math>e = e_0 \sin \omega t</math>                  where <math>e_0 = NBA \omega</math>                  b) Maximum value of emf  <math>e_0 = NBA \omega</math>  <math>= 20 \times 200 \times 10^{-4} \times 3 \times 10^{-2} \times 50V</math>  <math>= 600 \text{ mV}</math>                  Maximum induced current <math>i_0 = \frac{e_0}{R} = \frac{600}{R} \text{ mA}</math>                  [Note 1: If the student calculates the value of the maximum induced emf and says that "since R is not given, the value of maximum induced current cannot be calculated", the <math>\frac{1}{2}</math> mark, for the last part, of the question, can be given.]                  [Note 2: The direction of magnetic field has not been given. If the student takes this direction along the axis of rotation and hence obtains the value of induced emf and, therefore, maximum current, as zero, award full marks for this part.]</p> <p style="text-align: center;"><b>OR</b></p> <table border="1" data-bbox="284 1081 1185 1228"> <tr> <td>a) Labelled diagram of a step up transformer</td> <td>1 <math>\frac{1}{2}</math></td> </tr> <tr> <td>Derivation of ratio of secondary and primary voltage</td> <td>2</td> </tr> <tr> <td>b) Calculation of number of turns in the secondary</td> <td>1 <math>\frac{1}{2}</math></td> </tr> </table> <p>a)</p>  <p>Soft iron core</p> <p>Primary</p> <p>Secondary</p> <p>Alternatively</p>  <p>Soft iron core</p> <p>Primary</p> <p>Secondary</p> <p>[Note: Deduct <math>\frac{1}{2}</math> mark, if labeling is not done]</p>	a) Labelled diagram of a step up transformer	1 $\frac{1}{2}$	Derivation of ratio of secondary and primary voltage	2	b) Calculation of number of turns in the secondary	1 $\frac{1}{2}$	<p><math>\frac{1}{2}</math></p> <p><math>\frac{1}{2}</math></p> <p><math>\frac{1}{2}</math></p> <p><math>\frac{1}{2}</math></p> <p><math>\frac{1}{2}</math></p> <p><math>\frac{1}{2}</math></p> <p><math>\frac{1}{2}</math></p> <p>5</p> <p>1 <math>\frac{1}{2}</math></p>	
a) Labelled diagram of a step up transformer	1 $\frac{1}{2}$								
Derivation of ratio of secondary and primary voltage	2								
b) Calculation of number of turns in the secondary	1 $\frac{1}{2}$								



	<p>a) When ac voltage is applied to primary coil the resulting current produces an alternating magnetic flux, which also links the secondary coil. The induced emf, in the secondary coil, having <math>N_s</math> turns, is</p> $e_s = -N_s \frac{d\phi}{dt}$ <p>This flux, also induces an emf, called back emf, in the primary coil.</p> $e_p = -N_p \frac{d\phi}{dt}$ <p>But <math>e_p = V_p</math> and <math>e_s = V_s</math> <math>\Rightarrow \frac{V_s}{V_p} = \frac{N_s}{N_p}</math></p> <p>For an ideal transformer</p> $I_p V_p = I_s V_s$ $\Rightarrow \frac{V_s}{V_p} = \frac{I_p}{I_s}$ <p>b) <math>\frac{N_s}{N_p} = \frac{V_s}{V_p}</math></p> $\frac{N_s}{3000} = \frac{220}{2200}$ <p><math>\therefore N_s = 300</math></p>	<p><math>\frac{1}{2}</math></p> <p><math>\frac{1}{2}</math></p> <p><math>\frac{1}{2}</math></p> <p><math>\frac{1}{2}</math></p> <p><math>\frac{1}{2}</math></p> <p><math>\frac{1}{2}</math></p>	<p>5</p>						
<p>Q26</p>	<table border="1" style="width: 100%; border-collapse: collapse;"> <tr> <td style="padding: 5px;">a) Distinction between unpolarised and linearly polarized light</td> <td style="text-align: right; padding: 5px;">2</td> </tr> <tr> <td style="padding: 5px;">Obtaining linearly polarized Light</td> <td style="text-align: right; padding: 5px;">1</td> </tr> <tr> <td style="padding: 5px;">b) Calculation of intensity of light</td> <td style="text-align: right; padding: 5px;">2</td> </tr> </table> <p>a) In an unpolarized light, the oscillations, of the electric field, are in random directions, in planes perpendicular to the direction of propagation. For a polarized light, the oscillations are aligned along one particular direction. Alternatively</p> <p>Polarized light can be distinguished, from unpolarized light, when it is allowed to pass through a polaroid. Polarized light does can show change in its intensity, on passing through a Polaroid; intensity remains same in case of unpolarized light.</p> <p>When unpolarised light wave is incident on a polaroid, then the electric vectors along the direction of its aligned molecules, get absorbed; the electric vector, oscillating along a direction</p>	a) Distinction between unpolarised and linearly polarized light	2	Obtaining linearly polarized Light	1	b) Calculation of intensity of light	2	<p>1</p> <p>1</p> <p>1</p>	
a) Distinction between unpolarised and linearly polarized light	2								
Obtaining linearly polarized Light	1								
b) Calculation of intensity of light	2								

	<p>perpendicular to the aligned molecules, pass through. This light is called linearly polarized light.</p> <p>b) According to Malus' Law:  <math>I = I_0 \cos^2 \theta</math></p> <p><math>\therefore I = \left(\frac{I_0}{2}\right) \cos^2 \theta</math>, where <math>I_0</math> is the intensity of unpolarized light.</p> <p><math>\theta = 60^\circ</math> (given)</p> <p><math>I = \frac{I_0}{2} \cos^2 60^\circ = \frac{I_0}{2} \times \left(\frac{1}{2}\right)^2</math></p> <p><math>= \frac{I_0}{8}</math></p> <p style="text-align: center;"><b>OR</b></p> <table border="1" style="width: 100%; border-collapse: collapse;"> <tr> <td style="padding: 5px;">a) Explanation of two features (distinguishing between interference pattern and diffraction pattern.)</td> <td style="text-align: right; padding: 5px;">2</td> </tr> <tr> <td style="padding: 5px;">b) Calculation of angular width of central maxima</td> <td style="text-align: right; padding: 5px;">2</td> </tr> <tr> <td style="padding: 5px;">Estimation of number of fringes</td> <td style="text-align: right; padding: 5px;">1</td> </tr> </table> <p><b>a)</b></p> <table border="1" style="width: 100%; border-collapse: collapse;"> <thead> <tr> <th style="width: 50%; padding: 5px;">Interference Pattern</th> <th style="width: 50%; padding: 5px;">Diffraction pattern</th> </tr> </thead> <tbody> <tr> <td style="padding: 5px;">1) All fringes are of equal width.</td> <td style="padding: 5px;">1) Width of central maxima is twice the width of higher order bands.</td> </tr> <tr> <td style="padding: 5px;">2) Intensity of all bright bands is equal.</td> <td style="padding: 5px;">2) Intensity goes on decreasing for higher order of diffraction bands.</td> </tr> </tbody> </table> <p>[Note: Also accept any other two correct distinguishing features.]</p> <p>b) Angular width of central maximum</p> $\omega = \frac{2\lambda}{a}$ $= \frac{2 \times 500 \times 10^{-9}}{0.2 \times 10^{-3}} \text{ radian}$ $= 5 \times 10^{-3} \text{ radian}$ $\beta = \frac{\lambda D}{d}$ <p>Linear width of central maxima in the diffraction pattern</p> $\omega' = \frac{2\lambda D}{a}$ <p>Let 'n' be the number of interference fringes which can be accommodated in the central maxima</p>	a) Explanation of two features (distinguishing between interference pattern and diffraction pattern.)	2	b) Calculation of angular width of central maxima	2	Estimation of number of fringes	1	Interference Pattern	Diffraction pattern	1) All fringes are of equal width.	1) Width of central maxima is twice the width of higher order bands.	2) Intensity of all bright bands is equal.	2) Intensity goes on decreasing for higher order of diffraction bands.	<p>1</p> <p><math>\frac{1}{2}</math></p> <p><math>\frac{1}{2}</math></p> <p>5</p> <p> </p> <p>1+1</p> <p><math>\frac{1}{2}</math></p> <p><math>\frac{1}{2}</math></p> <p>1</p> <p><math>\frac{1}{2}</math></p>	<p>5</p>
a) Explanation of two features (distinguishing between interference pattern and diffraction pattern.)	2														
b) Calculation of angular width of central maxima	2														
Estimation of number of fringes	1														
Interference Pattern	Diffraction pattern														
1) All fringes are of equal width.	1) Width of central maxima is twice the width of higher order bands.														
2) Intensity of all bright bands is equal.	2) Intensity goes on decreasing for higher order of diffraction bands.														





	$\therefore n \times \beta = \omega'$ $n = \frac{2\lambda D}{a} \times \frac{d}{\lambda D}$ $n = \frac{2d}{a}$ <p>[Award the last ½ mark if the student writes the answers as 2 (taking <math>d=a</math>), or just attempts to do these calculation.]</p>	½	5
--	---	---	---